

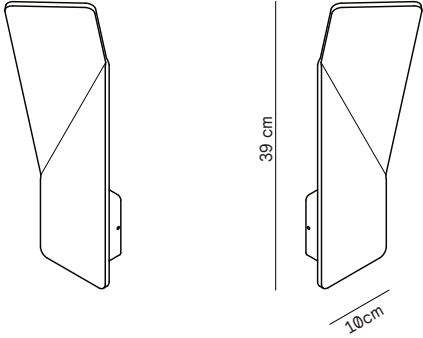



BENT WALL

<p>PRODUCT / PRODUKT / PRODUCT / PRODUIT</p>  <p>230V 4W IP54    </p>	<p>VERPAKKING / VERPACKUNG PACKING / EMBALLAGE</p>  <p>GROSS WEIGHT 1,15 KG</p>
--	---

SPECIFICATIES	SPEZIFIKATIONS	SPECIFICATIONS	SPECIFICATIONS
<p>100-240V/50-60Hz Vermogen armatuur 4W Klasse I armatuur IP54,</p> <p>Gewicht: 0,9 / 1,6 KG CE - Conform marking Voldoet aan de EU richtlijn 2002/96/EC</p>	<p>100-240V/50-60Hz Anschlussleistung 4W Schutzklasse I Schutzart IP 54,</p> <p>Gewicht: 0,9 / 1,6 KG CE - Konformitätszeichen Dieses Product entspricht der EUR ichtlinie 2002/96/EC</p>	<p>100-240V/50-60Hz Luminaire wattage 4W Safety class I Protection class IP 54,</p> <p>Weight: 0,9 / 1,6 KG CE - Conformity mark This product complies with EU Directive 2002/96/EC</p>	<p>100-240V/50-60Hz Puissance raccordée 4W Classe de protection I Degré de protection IP 54,</p> <p>Le poids: 0,9 / 1,6 KG CE - Sigle de conformité Ce produit est conforme a la Directive ED 2002/96/EC</p>

VEILIGHEID	SICHERHEIT	SAFETY INDICES	SECURITE
<p>De fabrikant is ontslagen van zijn aansprakelijkheid, wanneer de schade is veroorzaakt door oneigenlijk gebruik of installatie. Als een armatuur is gemodificeerd, de personen verantwoordelijk voor de modificatie moet worden beschouwd als fabrikant.</p>	<p>Der Hersteller übernimmt keine Haftung für Schäden, die durch unsachgemäßen Einsatz oder Montage entstehen. Werden nachträglich Änderungen an der Leuchte vorgenommen, so gilt derjenige als Hersteller, der diese Änderungen vornimmt.</p>	<p>The manufacturer is then discharged from liability when damage is caused by improper use or installation. If any luminaire is subsequently modified, the persons responsible for the modification shall be considered as manufacturer.</p>	<p>Le fabricant décline toute responsabilité résultant d'une mise en œuvre ou d'une installation inappropriée du produit. Toutes les modifications apportées au luminaire se feront sous la responsabilité exclusive de celui qui les effectuera.</p>

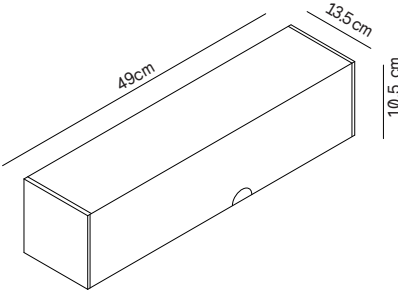
INSTALLATIE	ISTALLATIE	INSTALATTION	L'INSTALLATION
---	---	---	---

BENT WALL

AFMETINGEN / ABMESSUNGEN / DIMENSIONS / DIMENSIONS

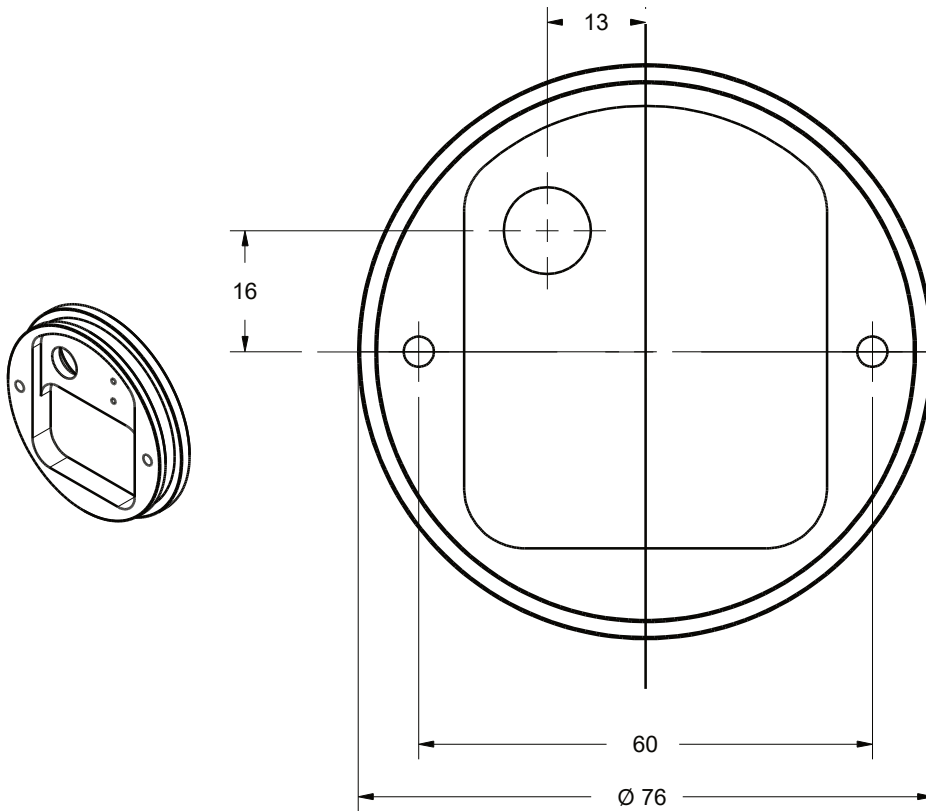

UNDO MOUNTING MATERIAL

INSTALATION

